

Section 1 – Typical Street Sections

<u>Drawing No.</u>	<u>Description</u>
101	Local
102	Collector with Striped Median
103	Collector with Bike Path
104	Arterial – 4 Lanes Divided
104A	Arterial – 2 Lanes Divided
105	Highway – 4 Lanes Divided
106	Highway – 6 Lanes Divided
107	Local Hillside Paved Road
108	Graded Road
109	Rural Local Street
110	Industrial
111	Local Intersection Design “L” Shape
112	Local Street Cul-de-sac
120	Intersection Design Rural Local Road
121	Driveway Grades

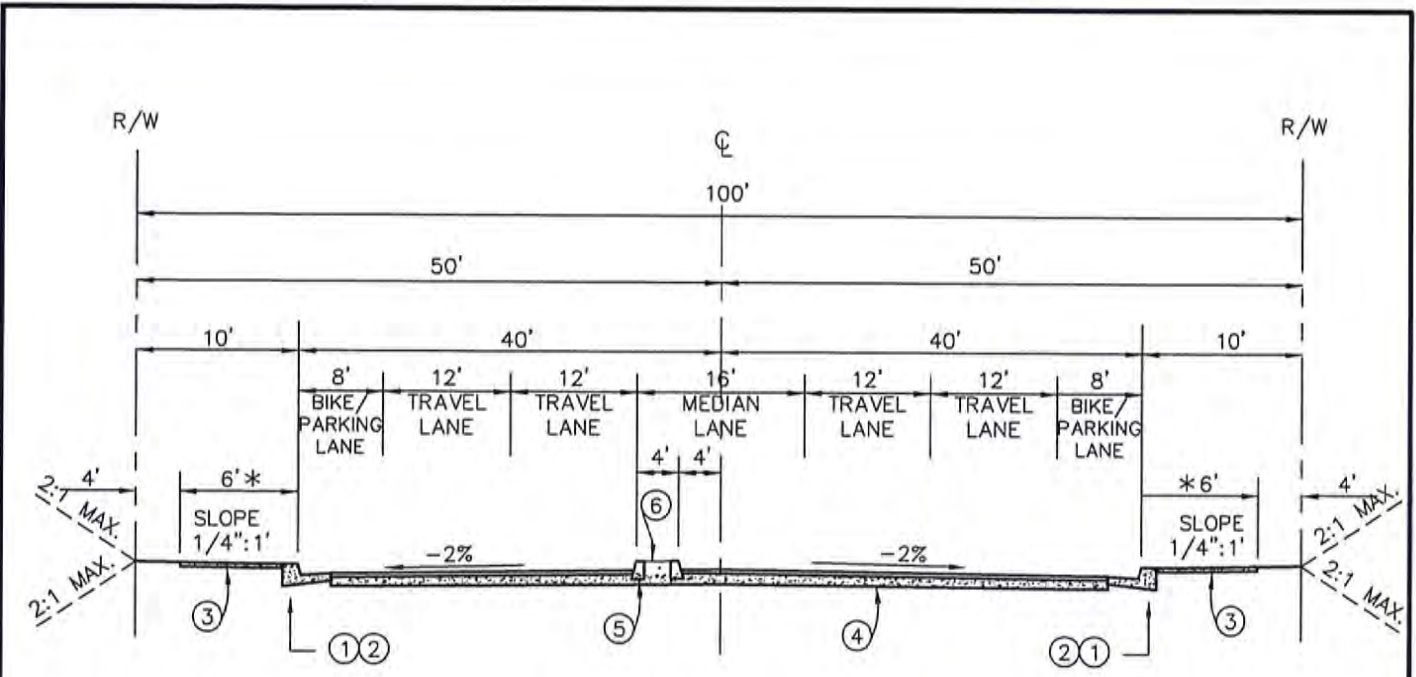

TYPICAL SECTION

NOTES:

- ① CURB AND GUTTER PER STD. DWG. NO. 200
- ② A.C. DIKE PER STD. DWG. NO. 200 **
- ③ SIDEWALK PER STD. DWG. NO. 220
- ④ PAVEMENT SECTION PER STD. DWG. NO. 240
- ⑤ MEDIAN CURB PER STD. DWG. NO. 200A
- ⑥ MEDIAN ISLAND LANDSCAPING PER STD. DWG. NO. 242, 242A AND 242B

* SIDEWALK REQUIREMENT PER DEVELOPMENT CODE
 ** LIMITED USE, SHORT TERM IMPROVEMENT PROJECTS



APPROVED: DIRECTOR OF PUBLIC WORKS
Alex Qishta DATE *11/17/16*

APPROVED: TOWN ENGINEER
Wood Dunaway R.C.E. 39827

▲ REVISD TO REFLECT CURRENT GENERAL PL.	-N-	8/24/16
REVISION	BY	DATE



Town of
Yucca Valley

ARTERIAL
(4 LANES DIVIDED)

STANDARD DRAWING NO. 104

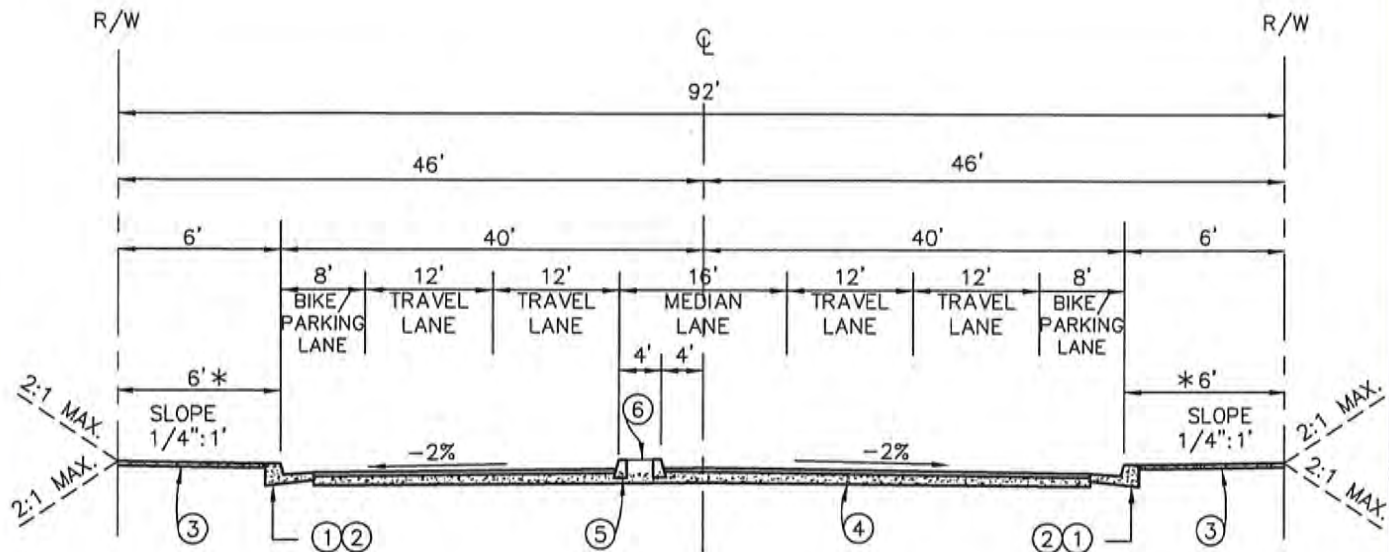

TYPICAL SECTION

NOTES:

- ① CURB AND GUTTER PER STD. DWG. NO. 200
- ② A.C. DIKE PER STD. DWG. NO. 202 **
- ③ SIDEWALK PER STD. DWG. NO. 220
- ④ PAVEMENT SECTION PER STD. DWG. NO. 240
- ⑤ MEDIAN CURB PER STD. DWG. NO. 200A
- ⑥ MEDIAN ISLAND LANDSCAPING PER STD. DWG. NO. 242, 242A, AND 242B

* SIDEWALK REQUIREMENT PER DEVELOPMENT CODE
 ** LIMITED USE, SHORT TERM IMPROVEMENT PROJECTS



APPROVED: DIRECTOR OF PUBLIC WORKS

Alex Wishta DATE *11/17/16*

APPROVED: TOWN ENGINEER

Noel Owsley R.C.E. 39827



Town of
Yucca Valley

HIGHWAY
(4 LANES DIVIDED)

▲ REVISED TO REFLECT CURRENT GENERAL PL. -N- 8/24/16

STANDARD DRAWING NO. 105

REVISION	BY	DATE

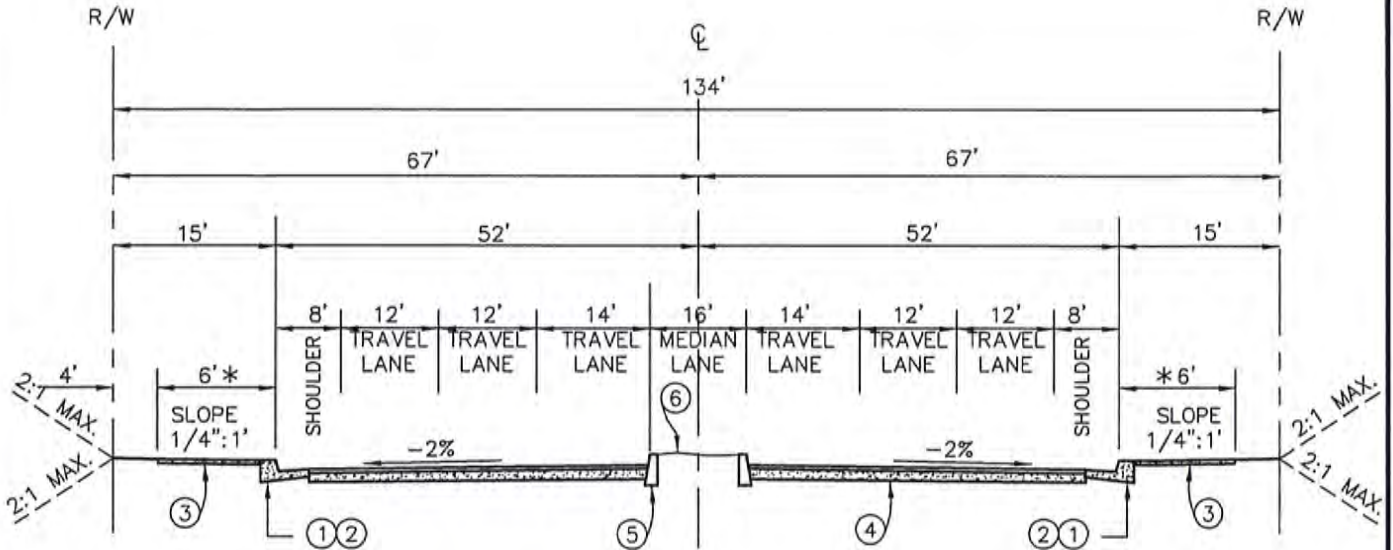

TYPICAL SECTION

NOTES:

- ① CURB AND GUTTER PER STD. DWG. NO. 200
- ② A.C. DIKE PER STD DWG. NO 202 **
- ③ SIDEWALK PER STD. DWG. NO. 220
- ④ PAVEMENT SECTION PER STD. DWG. NO. 240
- ⑤ MEDIAN CURB PER STD. DWG. NO. 200A
- ⑥ MEDIAN ISLAND LANDSCAPING PER STD. DWG. NO. 242, 242A AND 242B

* SIDEWALK REQUIREMENT PER DEVELOPMENT CODE

** LIMITED USE, SHORT TERM IMPROVEMENT PROJECTS



APPROVED: DIRECTOR OF PUBLIC WORKS

Alex Gishka DATE *11/17/16*

APPROVED: TOWN ENGINEER

Noel Owsley R.C.E. 39827

▲ REVISED TO REFLECT CURRENT GENERAL PL. -N- 8/24/16

REVISION	BY	DATE



Town of
Yucca Valley

HIGHWAY
(6 LANES DIVIDED)

STANDARD DRAWING NO. 106

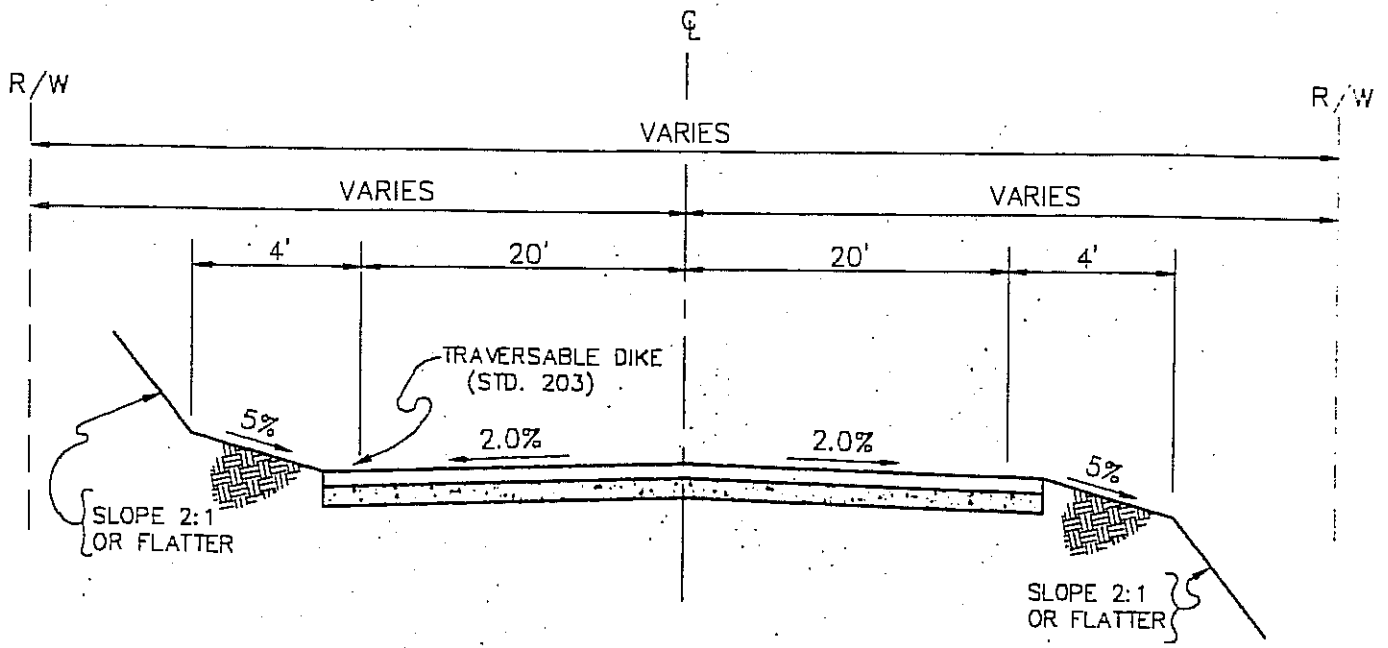

TYPICAL SECTION
HILLSIDE

NOTES:

1. STRUCTURAL SECTION OF ROADWAY SHALL BE DETERMINED FROM SOILS TEST AND SO INDICATED ON CONSTRUCTION PLANS.
2. CONSTRUCTION OUTSIDE R/W LINE SHALL REQUIRE EASEMENTS.
3. SLOPE REQUIREMENT MAY BE VARIED BY SUBMISSION OF SOILS REPORT.
4. ENTIRE SECTION MAY BE SLOPED AT 2% (NO CROWN) WITH PRIOR APPROVAL OF THE TOWN ENGINEER.

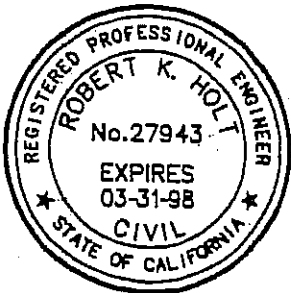

APPROVED: _____ DATE _____

APPROVED: TOWN ENGINEER
Robert K. Holt R.C.E. 27943

REVISION	BY	DATE

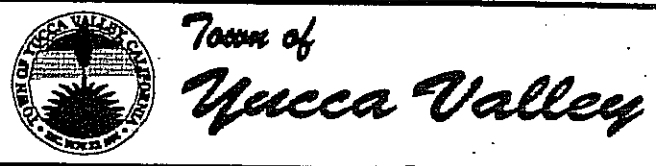

LOCAL HILLSIDE
PAVED ROAD

STANDARD DRAWING NO. 107

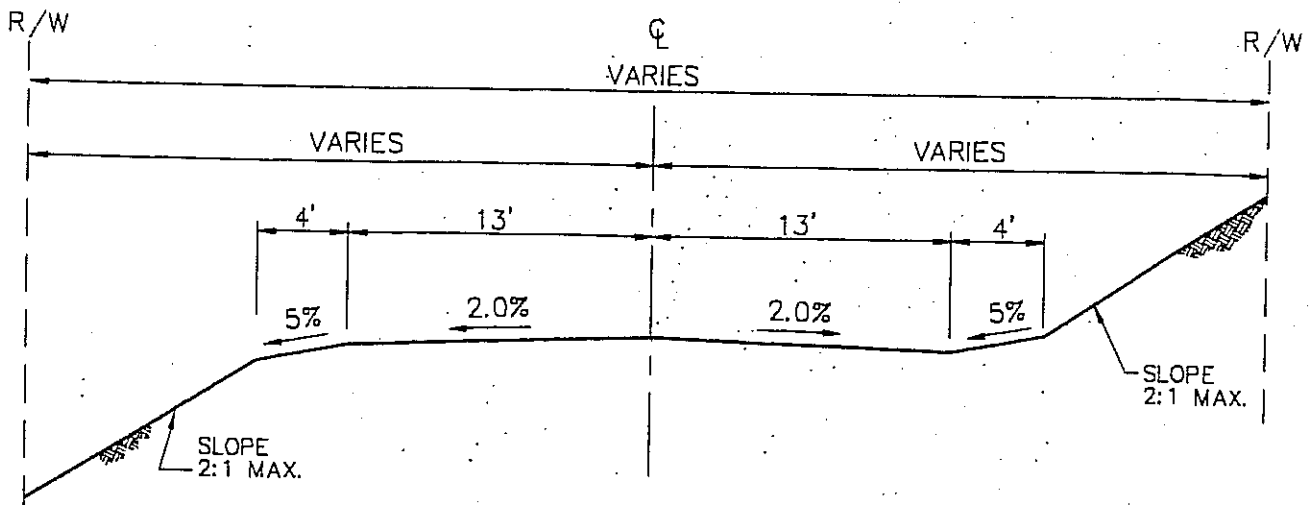

TYPICAL SECTION

NOTES:

1. DRAINAGE IMPROVEMENTS TO BE PLACED WHERE REQUIRED.
2. EMBANKMENTS PLACED WITHIN AREA OF THE TRAVELED WAY SHALL PROVIDE A STABLE ROADWAY.
3. INDICATE AREAS WHERE IMPORTED MATERIAL IS REQUIRED TO PROVIDE A STABLE ROADWAY.
4. CONSTRUCTION OUTSIDE R/W LINE SHALL REQUIRE EASEMENTS.
5. ENTIRE SECTION MAY BE SLOPED AT 2% (NO CROWN) WITH PRIOR APPROVAL OF THE TOWN ENGINEER.

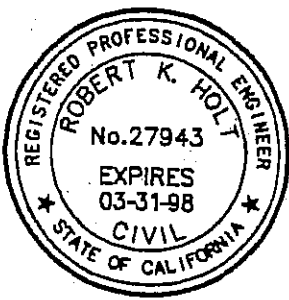

APPROVED: _____ DATE _____

APPROVED: TOWN ENGINEER
Robert K. Holt R.C.E. 27943

REVISION	BY	DATE



Town of
Yucca Valley

GRADED ROAD

STANDARD DRAWING NO. 108

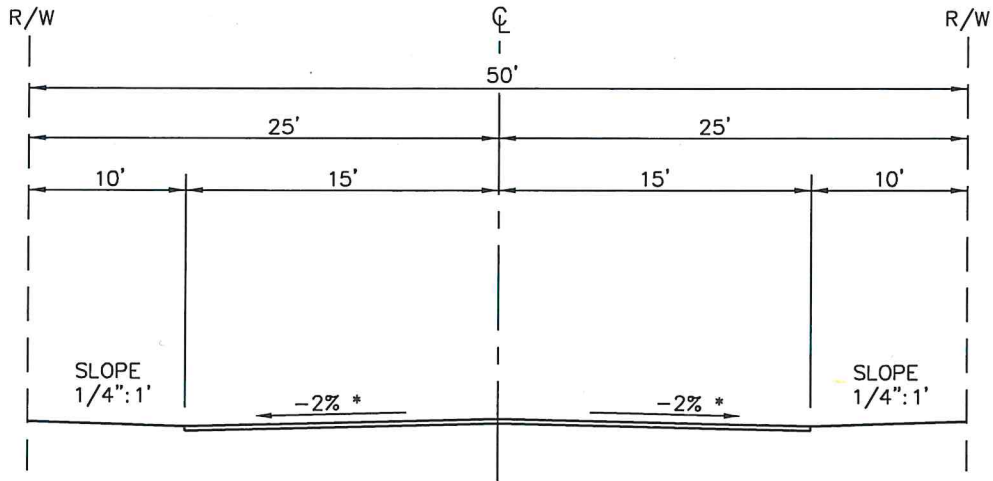

TYPICAL SECTION

NOTES:

1. STREET SURFACE (ASPHALT OR DIRT) SHALL BE PER DEVELOPMENT CONDITIONS OF APPROVAL.

* 2. INVERTED CROWN MAY BE USED WITH APPROVAL FROM THE TOWN ENGINEER



APPROVED: DIRECTOR OF PUBLIC WORKS

Alv Viste DATE 4/21/20

APPROVED: TOWN ENGINEER

Noel Owsley R.C.E. 39827



Town of
Yucca Valley

▲	REVISED TO REFLECT CURRENT GENERAL PL.	-N-	1/3/18
▲	REVISED EDGE OF PAVEMENT	-N-	8/30/24
	REVISION	BY	DATE

RURAL LOCAL STREET

STANDARD DRAWING NO. 109

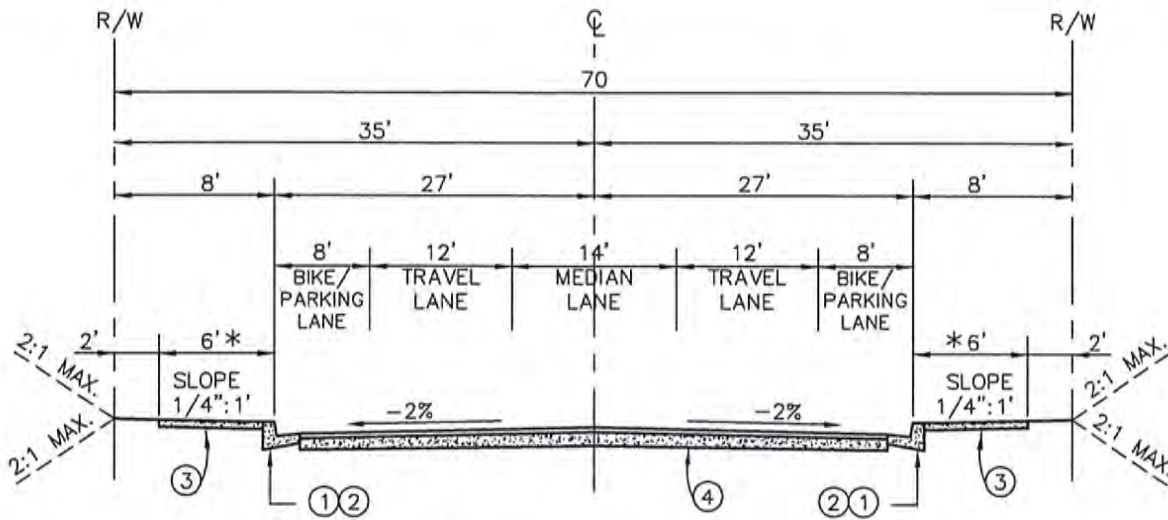

TYPICAL SECTION

LEVEL

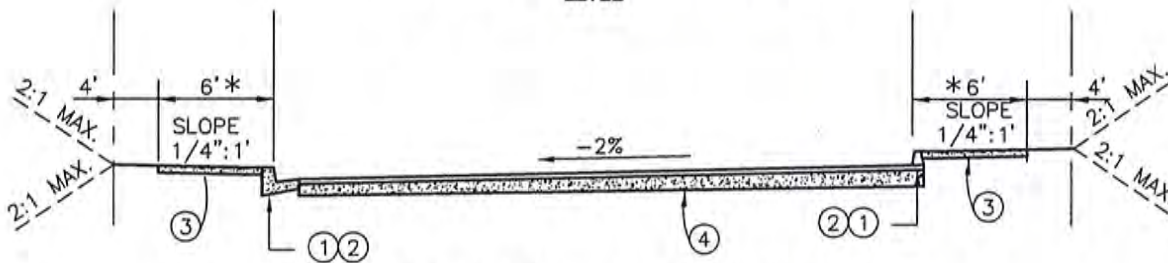

TYPICAL SECTION

TILT

NOTES:

- ① CURB AND GUTTER PER STD. DWG. NO. 200
- ② A.C. DIKE PER STD DWG. NO 202 **
- ③ SIDEWALK PER STD. DWG. NO. 220
- ④ PAVEMENT SECTION PER STD. DWG. NO. 240



* SIDEWALK REQUIREMENT PER DEVELOPMENT CODE
 ** LIMITED USE, SHORT TERM IMPROVEMENT PROJECTS

APPROVED: DIRECTOR OF PUBLIC WORKS

Alex Gishka DATE *11/17/16*

APPROVED: TOWN ENGINEER

Noel Owsley R.C.E. 39827



Town of
Yucca Valley

△ REVISED TO REFLECT CURRENT GENERAL PL. -N- 8/24/16

INDUSTRIAL

STANDARD DRAWING NO. 110

REVISION BY DATE

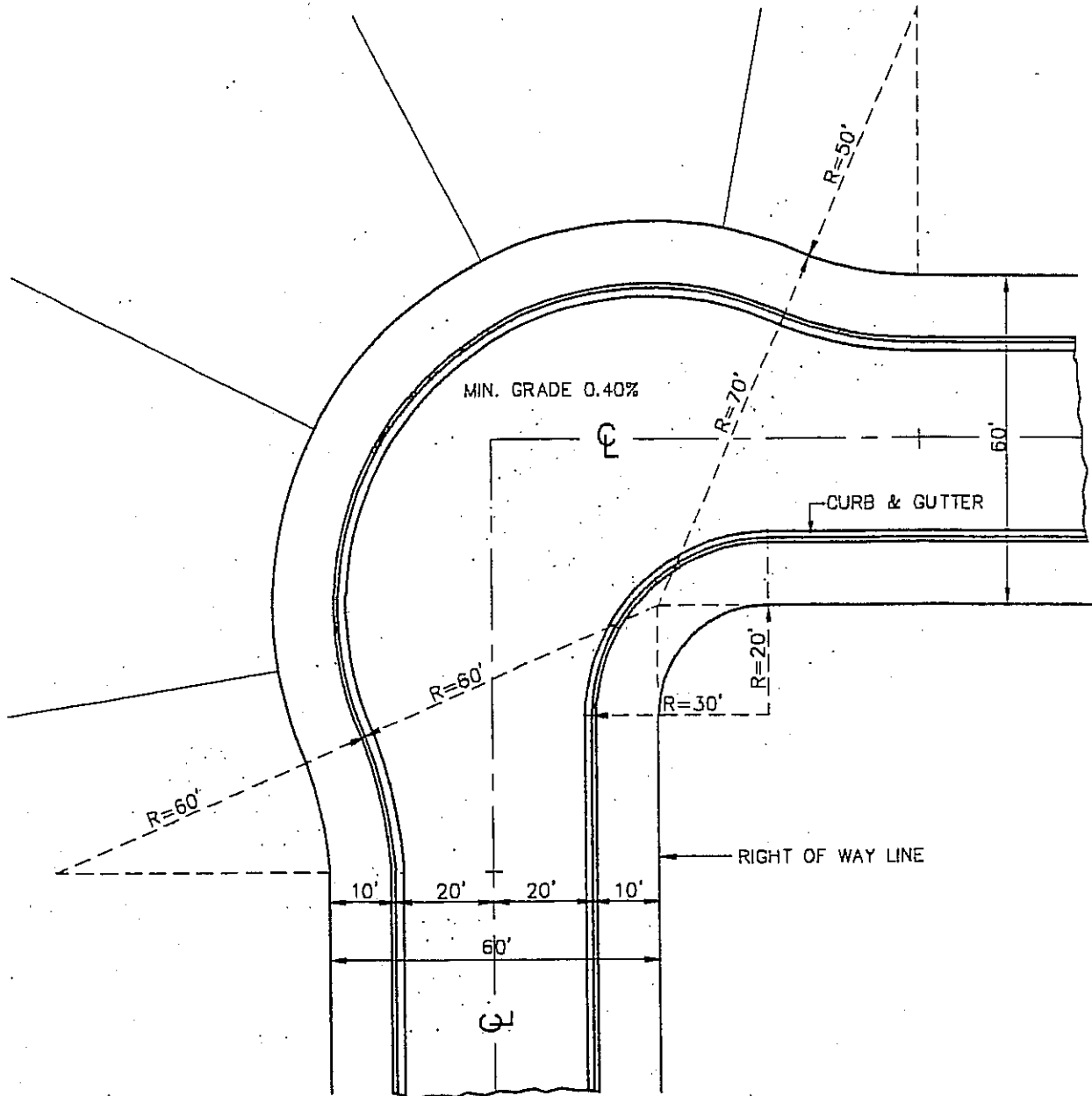

PLAN

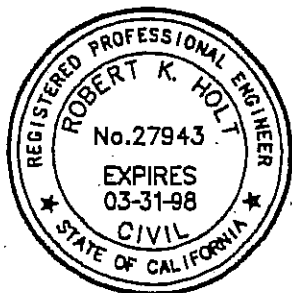

NOTES:

1. MINIMUM 0.40% ON ALL HORIZONTAL CURVE GRADES.
2. SEE STANDARD NO. 101 FOR TYPICAL SECTION.

APPROVED:

DATE _____

APPROVED: TOWN ENGINEER

Robert K. Holt

R.C.E. 27943



Town of
Yucca Valley

LOCAL INTERSECTION DESIGN
"L" SHAPE

STANDARD DRAWING NO. 111

REVISION

BY DATE

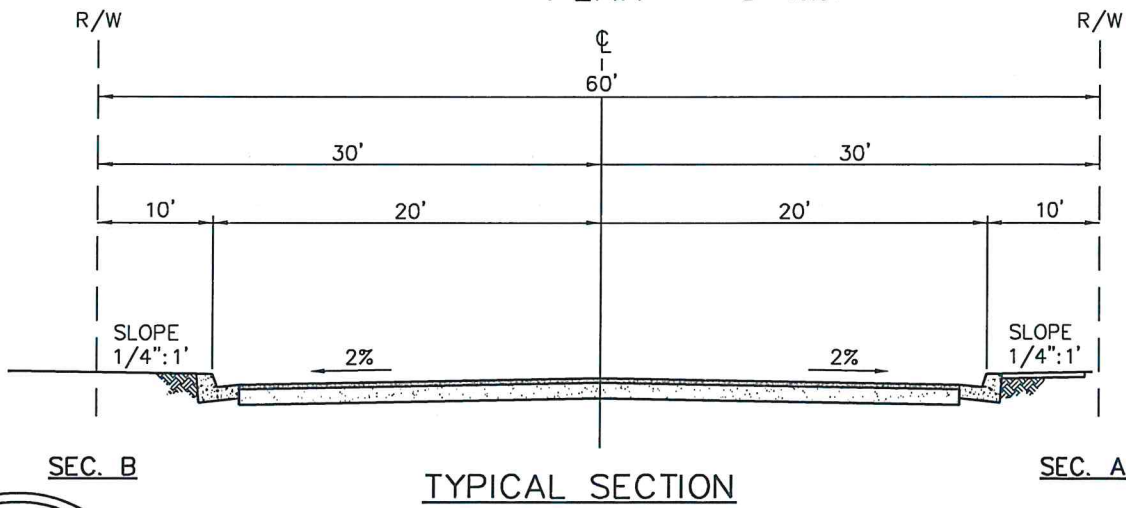
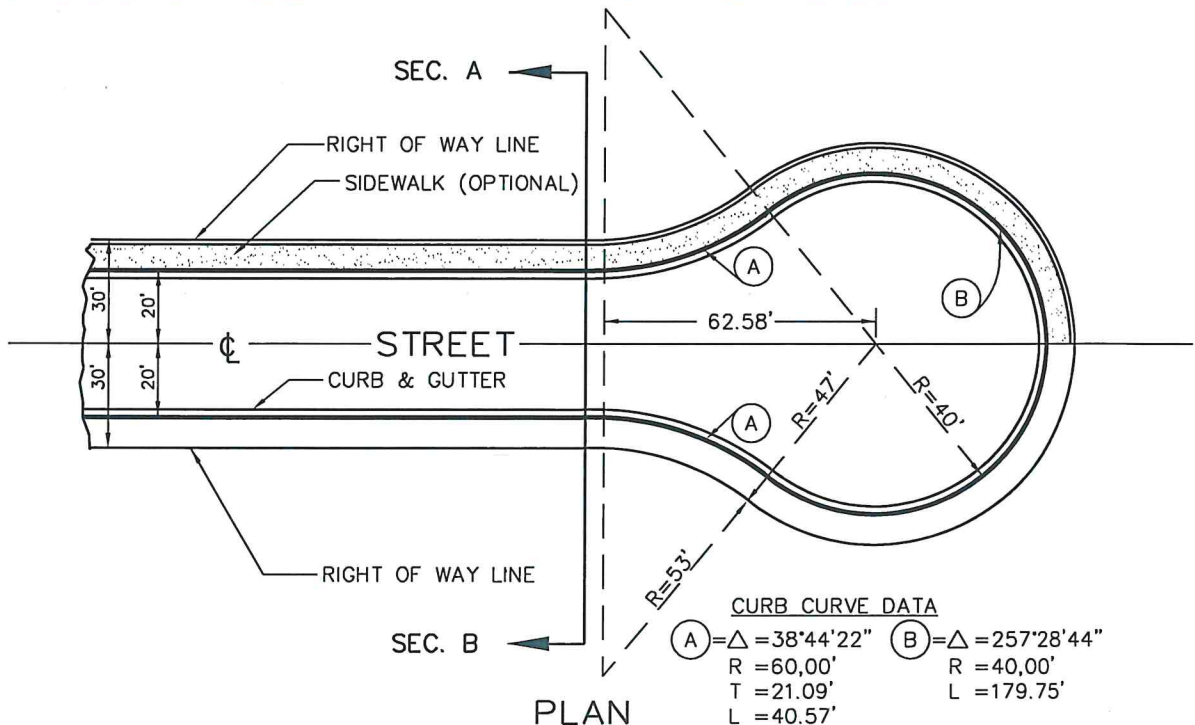

NOTES:

1. STRUCTURAL SECTION OF ROADWAY SHALL BE DETERMINED FROM SOIL TESTS AND SO INDICATED ON CONSTRUCTION PLANS.
2. CONSTRUCTION OUTSIDE R/W LINE SHALL REQUIRE EASEMENTS.
3. 0.4% GRADE MIN. ON GUTTER OF BULB.
4. TILT SECTION SHALL CONFORM TO LOCAL STREET STANDARD NO. 101.

APPROVED: DIRECTOR OF PUBLIC WORKS	
<i>Alex Gish...</i>	DATE <i>4/2/20</i>
APPROVED: TOWN ENGINEER	
<i>Noel Owsley</i>	R.C.E. 39827
▲ REVISED TO REFLECT CURRENT GENERAL PL.	-N- 1/3/18
▲ REVISED R/W WIDTH	-N- 8/30/24
REVISION	BY DATE



Town of
Yucca Valley

LOCAL STREET
CUL-DE-SAC

STANDARD DRAWING NO. 112

FULL WIDTH CONSTRUCTION

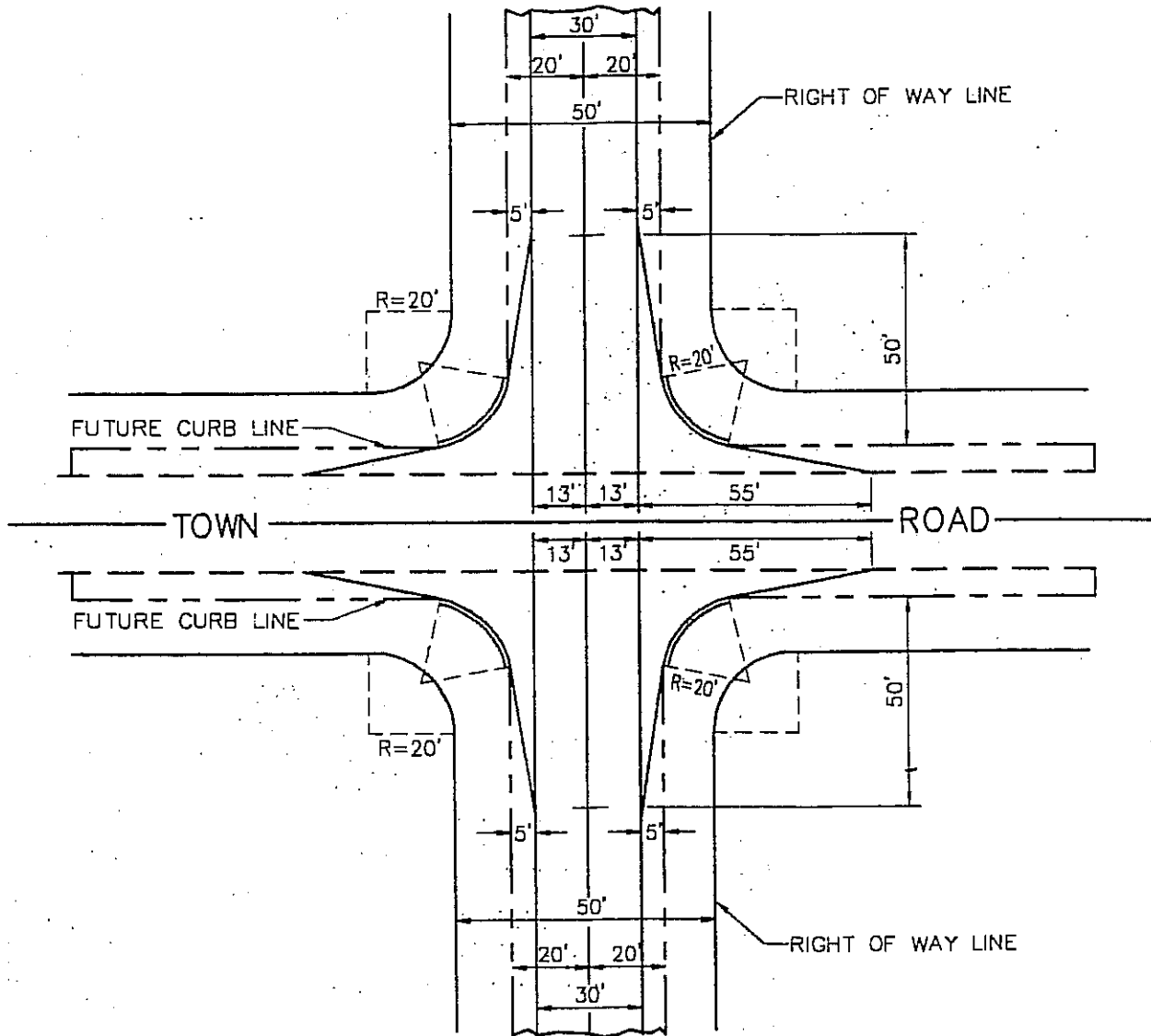

HALF WIDTH CONSTRUCTION

NOTES:

- SEE STANDARD NO. 101 FOR ROADWAY SECTIONS.

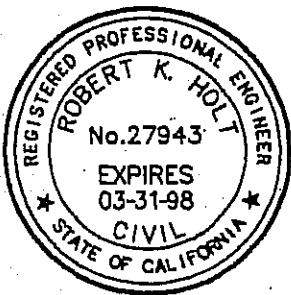

APPROVED:

DATE _____

APPROVED: TOWN ENGINEER

Robert K. Holt

R.C.E. 27943



Town of
Yucca Valley

INTERSECTION DESIGN
RURAL LOCAL ROAD

STANDARD DRAWING NO. 120

REVISION

BY DATE

